

**BUTTERFLY VALVE TEE LINKAGE ASSEMBLIES: ARRANGEMENT #6**

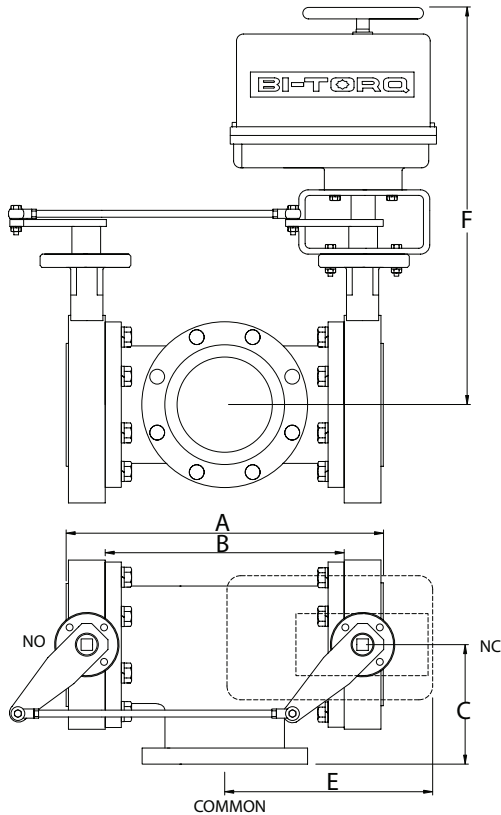

**ALL AVK CARBO-BOND/  
BI-TORQ THREE-WAY TEE  
LINKAGES CONSIST OF:**

- 2) LUG STYLE BUTTERFLY VALVES WITH EPDM, BUNA-N AND VITON SEAT OPTIONS
- 125# CAST IRON TEE
- PNEUMATIC OR ELECTRIC ACTUATOR
- CUSTOM MOUNTING HARDWARE
- FULL ASSEMBLY AND TESTING
- 6 ARRANGEMENT OPTIONS

**ELECTRIC WITH NEMA 4 ENCLOSURE**

VALVE SIZE	A	B	C	E	F	ACTUATOR
2"	10.69	9.00	6.19	10.64	15.47	BI-300-A-4-P1
2.5"	11.81	10.00	6.81	11.43	18.84	BI-400-A-4-P1
3"	12.81	11.00	7.31	11.93	19.08	BI-675-A-4-P1*
4"	15.05	13.00	8.55	13.17	19.82	BI-1000-A-4-P1*
5"	17.20	15.00	9.70	14.08	20.34	BI-1500-A-4-P1*
6"	18.20	16.00	10.20	16.45	22.96	BI-3800-A-4-P1*
8"	20.36	18.00	11.36	17.61	24.30	BI-3800-A-4-P1*
10"	24.68	22.00	13.68	19.89	25.56	BI-3800-A-4-P1*
12"	27.07	24.00	15.07	28.07	26.77	BI-5000-A-4-P1*

\*includes declutchable manual override

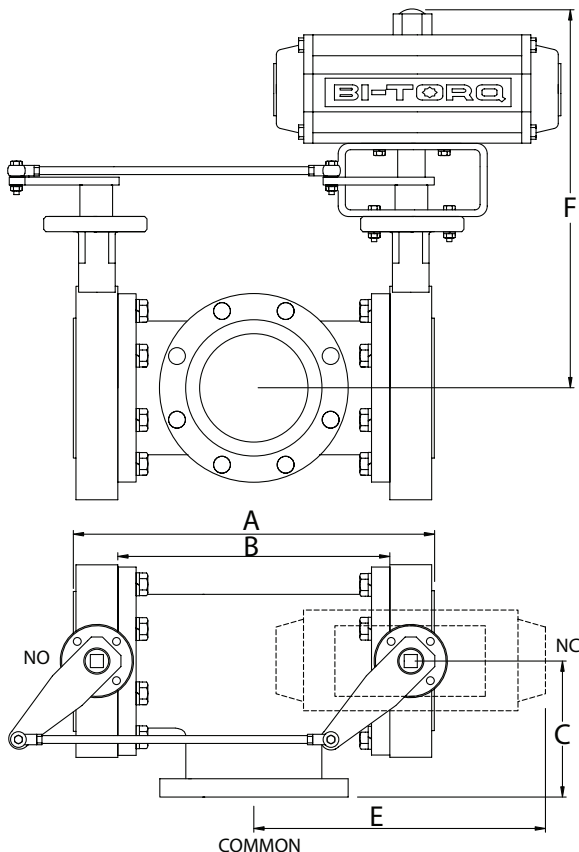

**DOUBLE ACTING PNEUMATIC**

VALVE SIZE	A	B	C	E	F	ACTUATOR
2"	10.69	9.00	6.19	9.38	10.30	PN-63-DA
2.5"	11.81	10.00	6.81	9.95	10.85	PN-63-DA
3"	12.81	11.00	7.31	11.39	14.74	PN-75-DA
4"	15.05	13.00	8.55	13.23	15.93	PN-85-DA
5"	17.20	15.00	9.70	15.05	16.96	PN-100-DA
6"	18.20	16.00	10.20	16.66	18.26	PN-115-DA
8"	20.36	18.00	11.36	19.79	20.96	PN-140-DA
10"	24.68	22.00	13.68	23.96	23.08	PN-160-DA
12"	27.07	24.00	15.07	26.39	26.86	PN-200-DA

**SPRING RETURN PNEUMATIC**

VALVE SIZE	A	B	C	E	F	ACTUATOR
2"	10.69	9.00	6.19	10.87	14.40	PN-85-SR
2.5"	11.81	10.00	6.81	12.16	15.46	PN-100-SR
3"	12.81	11.00	7.31	12.66	15.70	PN-100-SR
4"	15.05	13.00	8.55	15.01	17.23	PN-115-SR
5"	17.20	15.00	9.70	18.13	16.11	PN-140-SR
6"	18.20	16.00	10.20	18.63	19.62	PN-140-SR
8"	20.36	18.00	11.36	21.64	21.82	PN-160-SR
10"	24.68	22.00	13.68	25.00	23.83	PN-200-SR
12"	27.07	24.00	15.07	28.30	30.48	PN-270-SR